

Smart-e

MDXE-8/16/36/72

MATRIX USER MANUAL

User Manual



MDXE-72x72

















MDXE-72x72

For more information visit our website, or talk to one of our technical team
tel: +44 (0) 1306 628264 www.smart-e.co.uk

Smart-e

SYMBOLS

To ensure the safe and correct use of equipment, we use a range of symbols on the equipment and in the manuals. These symbols demonstrate the risk of physical harm or possible damage to property for the user or others and provide guidance on standards and disposal. Symbol indications and their meanings are as follows. Please ensure that you correctly understand these instructions before reading the manual and operating the equipment.

	WARNING. This symbol is used to indicate where important instructions are provided to ensure the correct operation of the equipment and user safety.
	To prevent fire or shock hazards, do not expose this equipment to rain or moisture. Also, do not use this equipment's polarized plug with an extension cord receptacle or other outlets unless the prongs can be fully inserted. Refrain from opening the cabinet as there are high voltage components inside. Please refer all servicing to qualified service personnel.
	This symbol warns user that uninsulated voltage within the unit may have sufficient magnitude to cause an electric shock. Therefore, it is dangerous to make any kind of contact with any part inside this unit.
	This is a WiFi product, which may cause or be susceptible to radio interference. Users may need to take additional measures to mitigate the interference.
	This is a Bluetooth product, which may cause or be susceptible to radio interference. Users may need to take additional measures to mitigate the interference.
	This is an RF Radio product, which may cause or be susceptible to radio interference. Users may need to take additional measures to mitigate the interference.
	This is an Infrared product, which may cause or be susceptible to frequency interference. Users may need to take additional measures to mitigate the interference.
	This is a product which conforms to HDBaseT specification.
	This product supports full High Definition 1080p resolution.
	This product supports 4K Ultra High Definition resolution.
	This product supports 3D definition display.
	CE certification means that the product has reached the directive safety requirements defined by the European Union.
	SGS certification means that the product has reached the quality inspection standards proposed by the world's largest quality standards body - SGS.
	This product has passed the ISO9001:2000 international quality certification
	EU-wide legislation, as implemented in each Member State, requires that waste electrical and electronic products carrying the mark (left) must be disposed of separately from normal household waste. This includes monitors and electrical accessories, such as signal cables or power cords. When you need to dispose of your equipment, please follow the guidance of your local authority, or ask the agent where you purchased the product. If you wish to dispose of used electrical and electronic products outside the European Union, please contact your local authority so as to comply with the correct disposal method.

WARNING



In order to ensure the reliable performance of the equipment and the safety of the user, please observe the following matters during the process of installation, use and maintenance. :

INSTALLATION

- ◆ Please do not use this product in the following places: places with high levels of dust or soot; places with high electric conductivity; places with corrosive or combustible gas; places exposed to high temperature, condensation, wind or rain; places subject to the occasion of vibration or impact.
- ◆ When installing screw or wiring, make sure that metal scraps and wire heads will not fall into the screw shaft of the equipment, as it could cause a fire, fault, or incorrect operation.
- ◆ When the installation work is completed, ensure there is nothing left on the ventilated vents of the equipment, including packaging items. Blocked vents may cause a fire, fault, incorrect operation.
- ◆ Avoid wiring and inserting cable plugs in a charged state, otherwise it is easy to cause shock, or electrical damage.
- ◆ The installation wiring should be strong reliable and earthed.
- ◆ For installations in areas of high interference, the installer should choose shielded cable as the high frequency signal input or output cable, so as to improve the anti-interference ability of the system.
- ◆ Switch off and disconnect the equipment from all power sources prior to handling, installation or wiring, otherwise it may cause electric shock or equipment damage.
- ◆ This product grounds to earth by the grounding wires. To avoid electric shocks, grounding wires and the earth must be linked together. Before the connection of input or output terminals, please make sure this product is correctly grounded.
- ◆ All terminals and wiring should be fully sheathed or otherwise covered before connecting the equipment to a power supply so as to avoid cause electric shock.

OPERATION AND MAINTENANCE

- ◆ Be sure to read this manual, and fully comply with the safety recommendations, before undertaking maintenance or operation.
- ◆ Do not touch terminals whilst the equipment is in a powered state, or it may cause a shock, incorrect operation.
- ◆ Switch off and disconnect the equipment from all power sources prior to cleaning or tightening terminals or connections. These operations can lead to electric shock in a live current state.
- ◆ Switch off and disconnect the equipment from all power sources prior to the connection or disconnection of communication signal cables, expansion modules, or other adapters, or it may cause damage to the equipment, incorrect operation, or lead to electric shock in a live current state.
- ◆ Do not dismantle the equipment and avoid damaging the internal electrical components. Please refer all servicing to qualified service personnel.

DISPOSAL

- ◆ Be sure to dispose of the equipment in accordance with local regulations.

CONTENTS

1	FUNCTION	6
2	FEATURES	7
3	SYSTEM COMPONENTS	8
3.1	MDXE DIGITAL MODULAR MATRIX CHASSIS.....	8
3.2	MDXE INPUT BLADES.....	8
3.3	MDXE OUTPUT BLADES.....	8
4	CHASSIS PANEL DESCRIPTION	9
5	INPUT / OUTPUT BLADES	14
5.1	INPUT BLADES.....	14
5.1.1	HDMI 4-WAY INPUT BLADE [MDXE-IP4-HDMI].....	14
5.1.2	DVI 4-WAY INPUT BLADE [MDXE-IP4-DVI].....	14
5.1.3	ANALOGUE 4-WAY INPUT BLADE [MDXE-IP4-VGA].....	14
5.1.4	HDbaseT 4-WAY RECEIVER BLADE [MDXE-RX4-HDBT].....	15
5.1.5	FIBRE 4-WAY RECEIVER BLADE [MDXE-RX4-MFB].....	15
5.1.6	HD/3G SDI InPUT BLADE [MDXE-IP4-3GSDI].....	15
5.2	OUTPUT BLADES	16
5.2.1	HDMI 4-WAY OUTPUT BLADE [MDXE-OP4-HDMI].....	16
5.2.2	DVI 4-WAY OUTPUT BLADE [MDXE-OP4-DVI].....	16
5.2.3	ANALOGUE 4-WAY OUTPUT BLADE.....	16
5.2.4	HDbaseT 8-WAY TRANSMIT BLADE [MDXE-TX4-HDBT].....	17
5.2.5	FIBRE 8-WAY TRANSMIT BLADE [MDXE-TX4-FIBRE].....	17
5.2.6	HD/3G SDI OUTPUT BLADE [MDXE-OP4-3GSDI].....	17
6	APPLICATION DIAGRAM	18
7	REMOTE CONTROL INTERFACES	19
7.1	RS232 SERIAL CONTROL PORT INTERFACE.....	19
7.2	KEYPAD CONTROL PORT INTERFACE.....	19
7.3	TCP/IP CONTROL PORT INTERFACE	19
7.3.1	TCP/IP CONNECTION VIA SWITCH.....	19
7.3.2	TCP/IP CONNECTION DIRECT VIA CROSS-CONNECT.....	19
8	ACCESSORIES	20
8.1	MULTIFORMAT ANALOGUE VIDEO ADAPTER CABLE.....	20
9	TECHNICAL SPECIFICATION	21
9.1	MDXE-8X8+ / 16X16+ / 36X36+	21
9.2	MDXE-IP4-HDMI / MDXE-OP4-HDMI.....	22
9.3	MDXE-IP4-DVI / MDXE-OP4-DVI	22
9.4	MDXE-IP4-VGA / MDXE-OP4-VGA.....	23
9.5	MDXE-RX4-HDBT / MDXE-TX4-HDBT	24
9.6	MDXE-RX4-MFB / MDXE-TX4-MFB	25
9.7	MDXE-IP4-3GSDI / MDXE-OP4-3GSDI.....	25
10	FRONT PANEL CONTROL	27
10.1	CHANNEL SELECTION	27
10.2	IP SETUP.....	28

10.3	PORT NUMBER.....	28
10.4	GATEWAY.....	29
10.5	SUBNET MASK.....	29
11	WEB BROWSER CONTROL	30
11.1	CHANNEL SELECTION	30
11.2	IP SETTINGS.....	31

1 FUNCTION

The MDXE Digital Modular Matrix (DMM+) series from Smart-e is a range of rack-mountable modular analogue/digital audio-visual matrix switches – providing a high-performance solution to analogue/digital matrix switching, with flexible configuration.

The MDXE series comprises:

- **A range of modular matrix chassis, supporting 8x8, 16x16, 36x36 and 72x72 Input and Output matrix switching**
- **A range of Input Blades – each supporting 4x independent switchable input ports. Input Blades are available for HDMI, DVI-D, Multi-format Analogue, HDBaseT, 3G-SDI and Fibre**
- **A range of Output Blades – each supporting 4x independently switchable and scalable output ports. Output Blades are available for HDMI, DVI-D, HDBaseT, 3G-SDI and Fibre**
- **A range of accessories including active cooling fan-trays, ventilation panels, blank panels and a redundant PSU**

Input and Output Blades can be mixed & matched to provide the user with a diverse solution in a single unified system.

All input/output Blade ports are fully independent, enabling full matrix switching capability between ports: one-to-one, or one-to-many.

DMM delivers analogue/digital hybrid capability – enabling the input of multi-format analogue video (VGA/RGBHV, Component-video YPbPr, S-video and Composite-video) sources to digital output (HDMI, DVI-D and HDBaseT). Analogue video is digitised and up-scaled as required up to HD 1080p.

The HDMI and DVI Input Blades provide active-input ports, enabling the installer to connect extended cable lengths ≤ 15 -meters.

The HDBaseT Input Blades enable remote connectivity to source devices fitted with a Smart-e 4K-TX866 Transmitter (or other compliant HDBaseT transmitter) ≤ 100 -meters over copper twisted pair cable. 24V power is supplied from the matrix to the transmitter through the twisted pair cabling.

The HDBaseT Output Blades enable remote connectivity to display devices fitted with a Smart-e 4K-RX866 Receiver (or other compliant HDBaseT receiver) ≤ 100 -meters over copper twisted pair cable. 24V power is supplied from the matrix to the transmitter through the twisted pair cabling.

Digital signal processing technology ensures that signals are transported without distortion and the best quality output is transmitted to the display device. Each output port can have its resolution set to match that of the connected screen ensuring best quality picture and seamless switching between inputs.

The matrix switching of MDXE Blade Inputs/Outputs fully supports bi-directional RS232 control and bi-directional Infrared control pass-through enabling control connectivity between remote source and display devices.

The MDXE matrices can be controlled by a variety of methods including:

- **Remote control, via Key Pad accessory.**
- **Remote control via RS232 serial command**
- **Remote control via TCP/IP Ethernet**
- **Integrated Web Browser**

2 FEATURES

- **19-inch Rack Mountable Form Factor.**
- **Chassis versions to support 8x8, 16x16, 36x36 and 72x72 matrices.**
- **Modular design enables variety of Input / Output blades to be populated within the matrix chassis.**
- **Input blades have 4x individually selectable input ports per blade.**
- **Output blades have 4x individually selectable output ports per blade.**
- **Supports multiple format input –**
 - **HDMI**
 - **DVI-D**
 - **Analogue (RGBHV, Component, Composite)**
 - **HDBaseT**
 - **3G-SDI**
 - **Fibre**
- **Supports multiple format output –**
 - **HDMI**
 - **DVI-D**
 - **Analogue (RGBHV, Component, Composite)**
 - **HDBaseT**
 - **3G-SDI**
 - **Fibre**
- **Full seamless digital switching between inputs/outputs**
- **Digitising and up-scaling of analogue input sources**
- **Internal Video Wall Processor**
- **Supports switch throughput of HDBaseT control (RS232 bi-directional, Infrared bi-directional)**
- **Fast channel switching for DVI 1.0 and HDMI 1.4**
- **HDMI HDCP compatible**
- **HDMI CEC compliant**
- **External control via RS232 serial.**
- **External control via TCP/IP.**
- **Integrated Web Browser**
- **Integrated cooling fan system (with manual activation temperature settings).**
- **Dual redundant power supply.**

3 SYSTEM COMPONENTS

3.1 MDXE DIGITAL MODULAR MATRIX CHASSIS

The following modular matrix chassis are available in the MDXE series:

Model SKU	Input Blade Slots	Max Inputs	Output Blade Slots	Max Outputs
MDX-8X8+	2	8	2	8
MDX-16X6+	4	16	4	16
MDX-36X36+	9	36	9	36
MDX-72X72+	18	72	18	72

3.2 MDXE INPUT BLADES

The following input blades are available in the MDXE series:

Model SKU	Input ports	Port Type
MDX-IP4-HDMI	4	HDMI [Type-A] (Plus 3.5mm stereo jack for external audio source)
MDX-IP4-DVI	4	DVI-D [DVI-D] (Plus 3.5mm stereo jack for external audio source)
MDX-IP4-VGA	4	Analogue [HD15] (Plus 3.5mm stereo jack for external audio source)
MDX-RX4-HDBT	4	HDBaseT
MDX-IP4-3GSDI	4	3G-SDI
MDX-RX4-MFB	4	Single Core Fibre

3.3 MDXE OUTPUT BLADES

The following output blades are available in the MDXE series:

Model SKU	Output ports	Port Type
MDX-OP4-HDMI	4	HDMI [Type-A] (Plus 3.5mm stereo jack providing de-embedded analogue audio output)
MDX-OP4-DVI	4	DVI-D [DVI-D] (Plus 3.5mm stereo jack for analogue audio output)
MDX-OP4-VGA	4	Analogue [HD15] (Plus 3.5mm stereo jack for analogue audio output)
MDX-TX4-HDBT	4	HDBaseT
MDX-OP4-3GSDI	4	3G-SDI
MDX-TX4-MFB	4	Single Core Fibre
VMX-TX4-HDBT	4	HDBaseT - Video Wall Capable
VMX-OP4-DVI	4	DVI-D and Audio - Video Wall Capable
VMX-TX-MFB	4	Single Core Fibre - Video Wall Capable
VMX-TXSDI	4	3G-SDI - Video Wall Capable

4 CHASSIS PANEL DESCRIPTION

Front Panel | MDX-8x8+

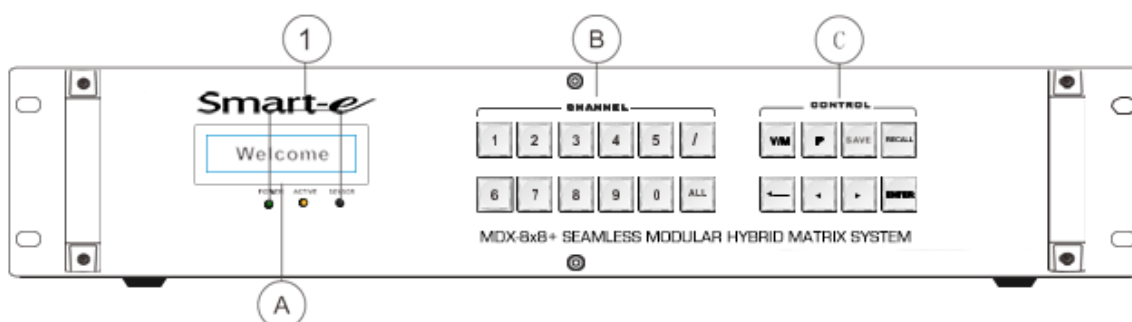

Rear Panel | MDXE-8x8+

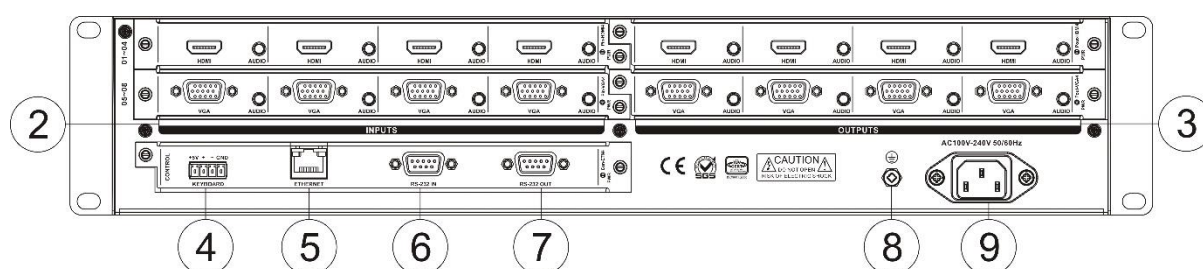

1 FRONT PANEL INDICATORS

- Power LED – Solidly Lit Green When Power Supplies Operating Correctly
- Active LED – Pulses Amber When Internal Processor Is Running
- Sensor – Infrared Sensor to Control Matrix Functionality

2 INPUT PORTS

Location of MDXE Input Blades

3 OUTPUT PORTS

Location of MDXE Output Blades

4 KEYPAD CONTROL INPUT

4-way input for control keypad

5 ETHERNET PORT

Ethernet port enabling connection of matrix to LAN and allowing control over TCP/IP

6 D9 CONNECTOR – RS232 In Control Port

Used to connect MDXE to control system (PC/SmartIP/3rd Party Controller)

7 D9 CONNECTOR – RS232 Out Port

Can be used to interconnect control systems where feedback or status is required from the MDXE

8 EARTHING POINT

9 SYSTEM IEC INLETS

Power supply inlets to power the internal boards of the MDXE (AC 100 – 240V 50/60Hz)

10 POC IEC MAINS INLETS

Power supply inlets to power remote transmitter and receiver units (TX/RX 4K-866s – 24V)

11 **BLANK SOCKET - NO BLADE CAN BE INSERTED IN THIS SLOT**

12 **INFRARED SWITCH SLOT - Contact Smart-e for More info on Infrared Applications**

A. **LCD DISPLAY**

B. **CHANNEL** - I/O channel selection

C. **CONTROL** - Matrix Commands

Front Panel | MDXE-16X16+

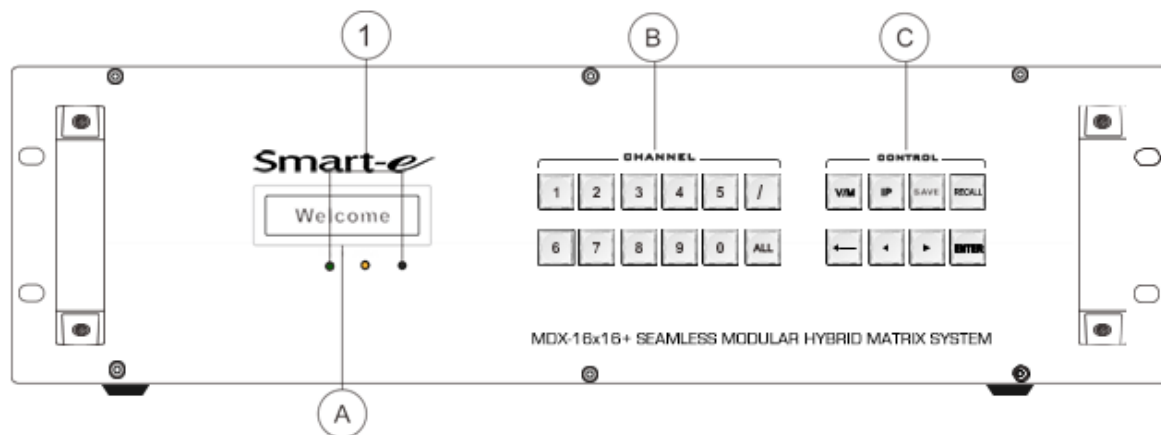

Rear Panel | MDXE-16X16+

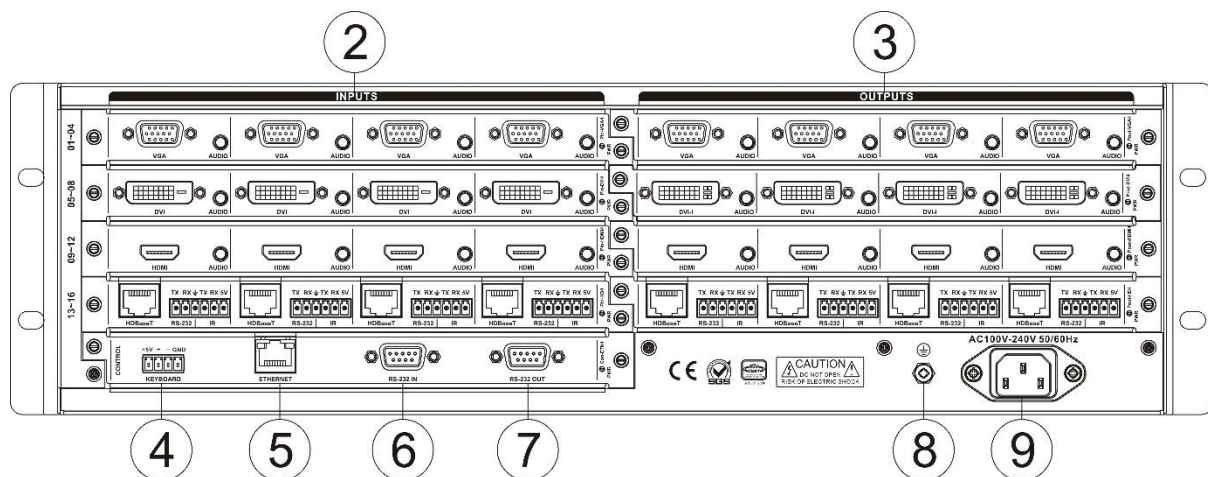

Front Panel | MDXE-36X36+

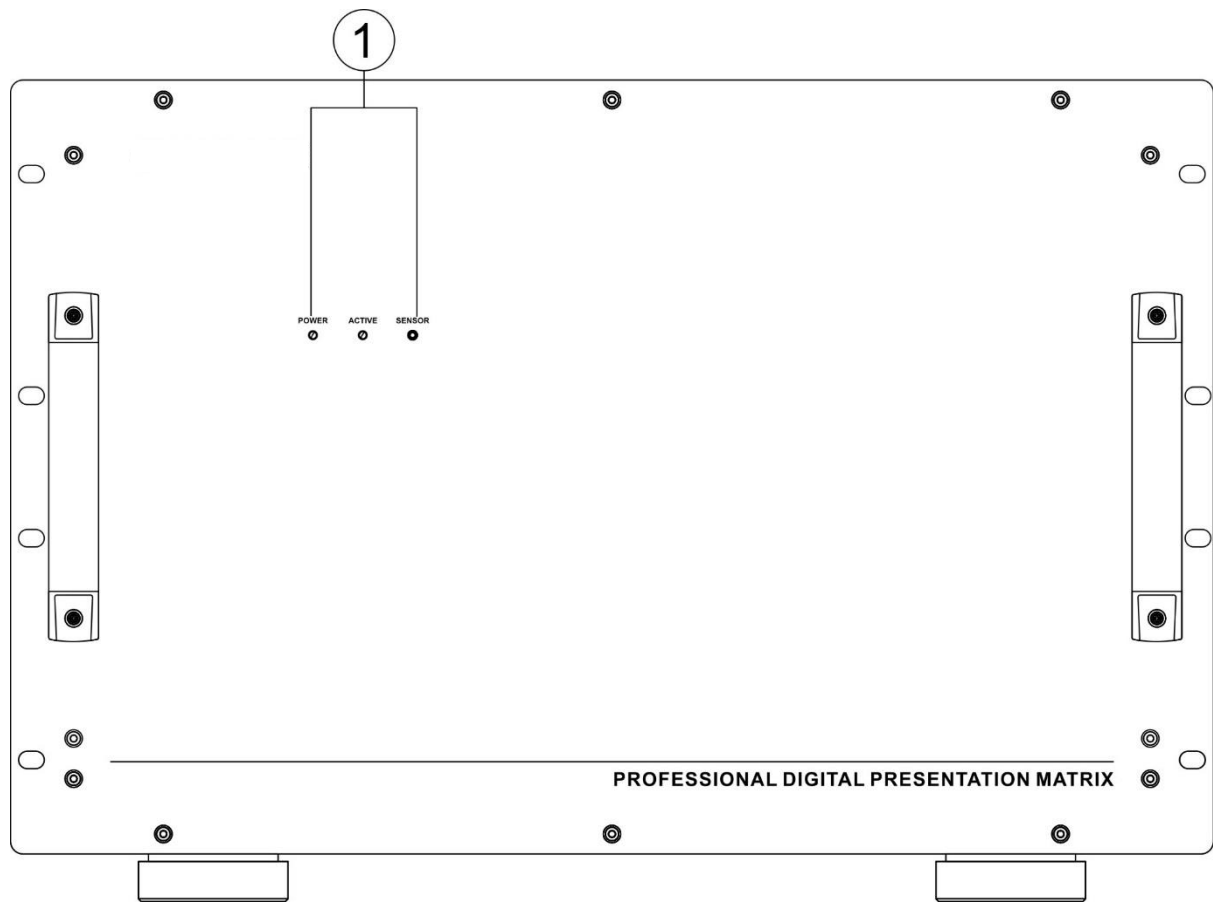

Rear Panel | MDXE-36X36+

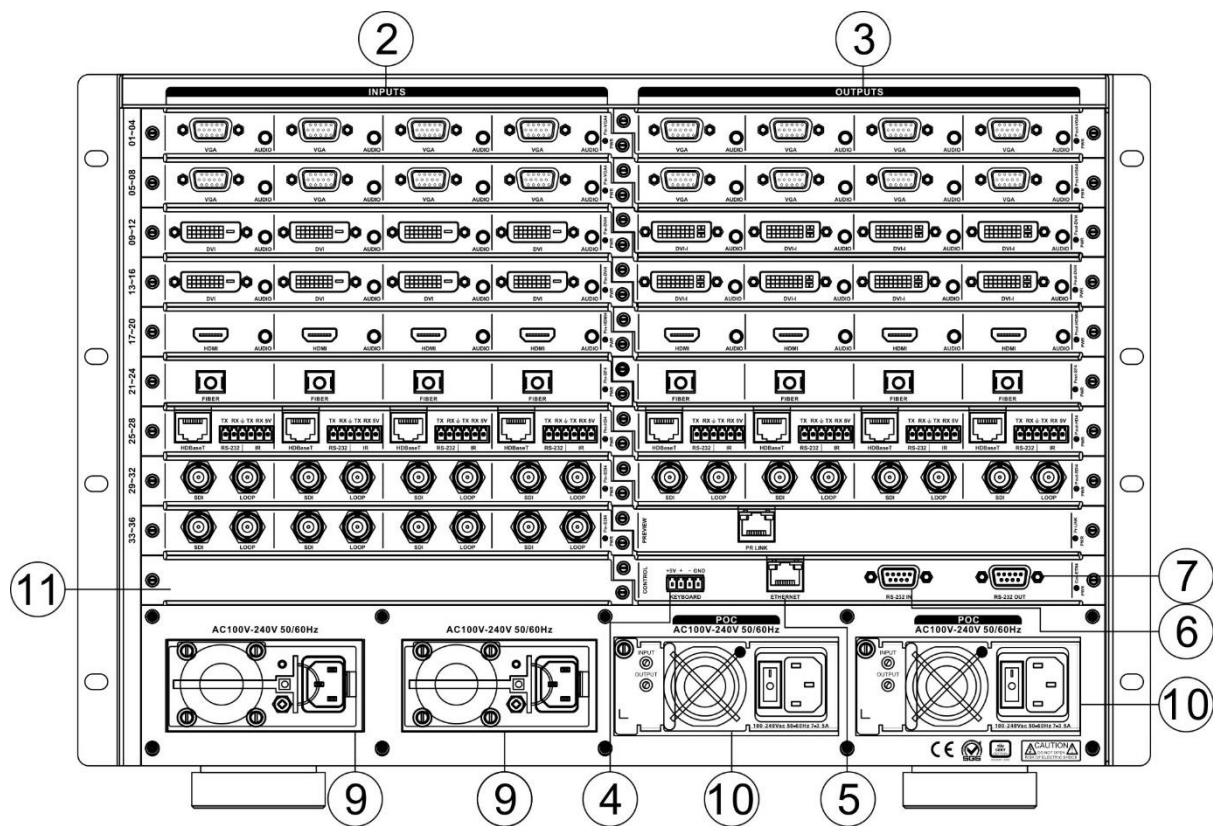

Front Panel | MDXE-72X72+

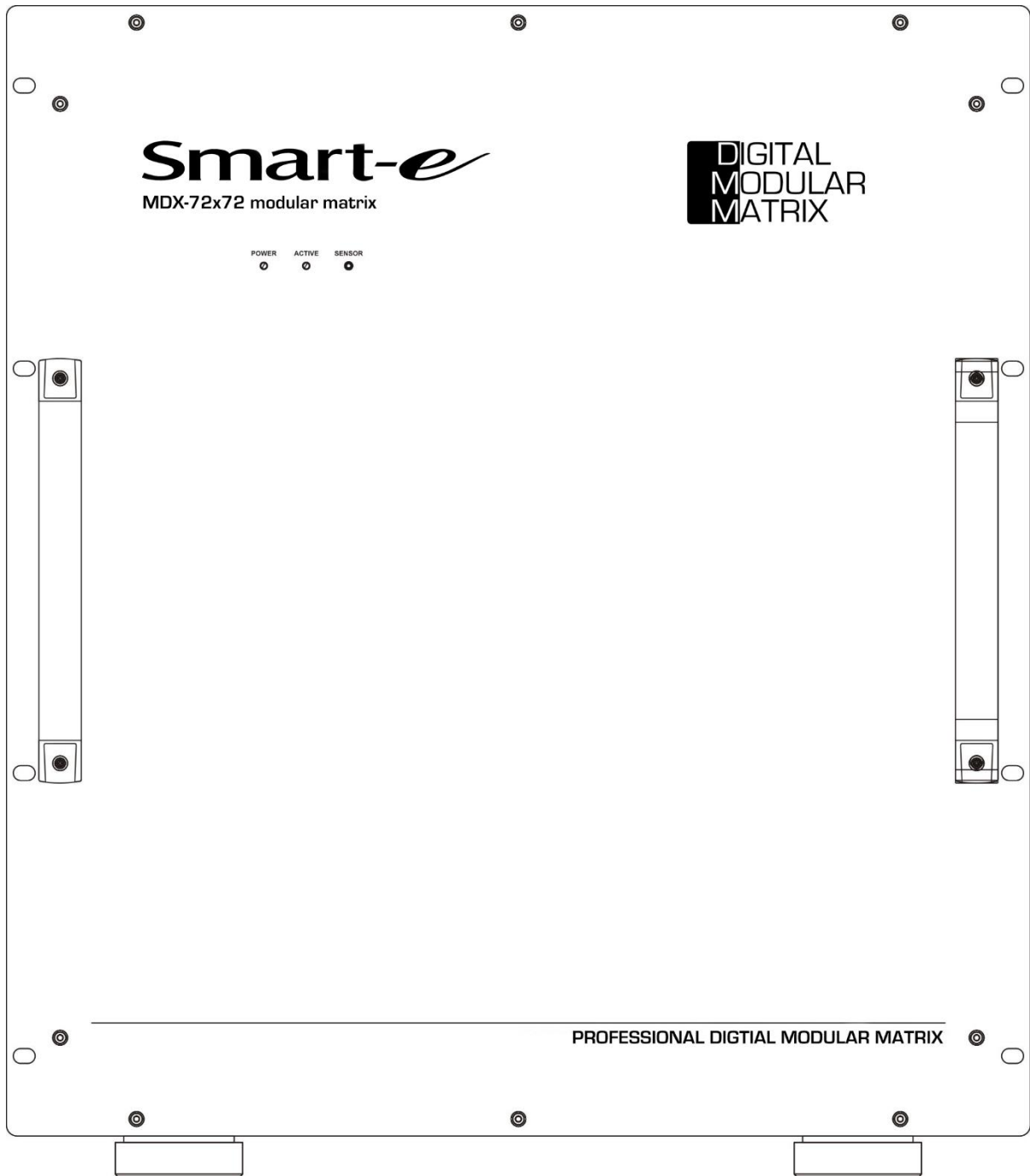

Rear Panel | MDXE-72X72+

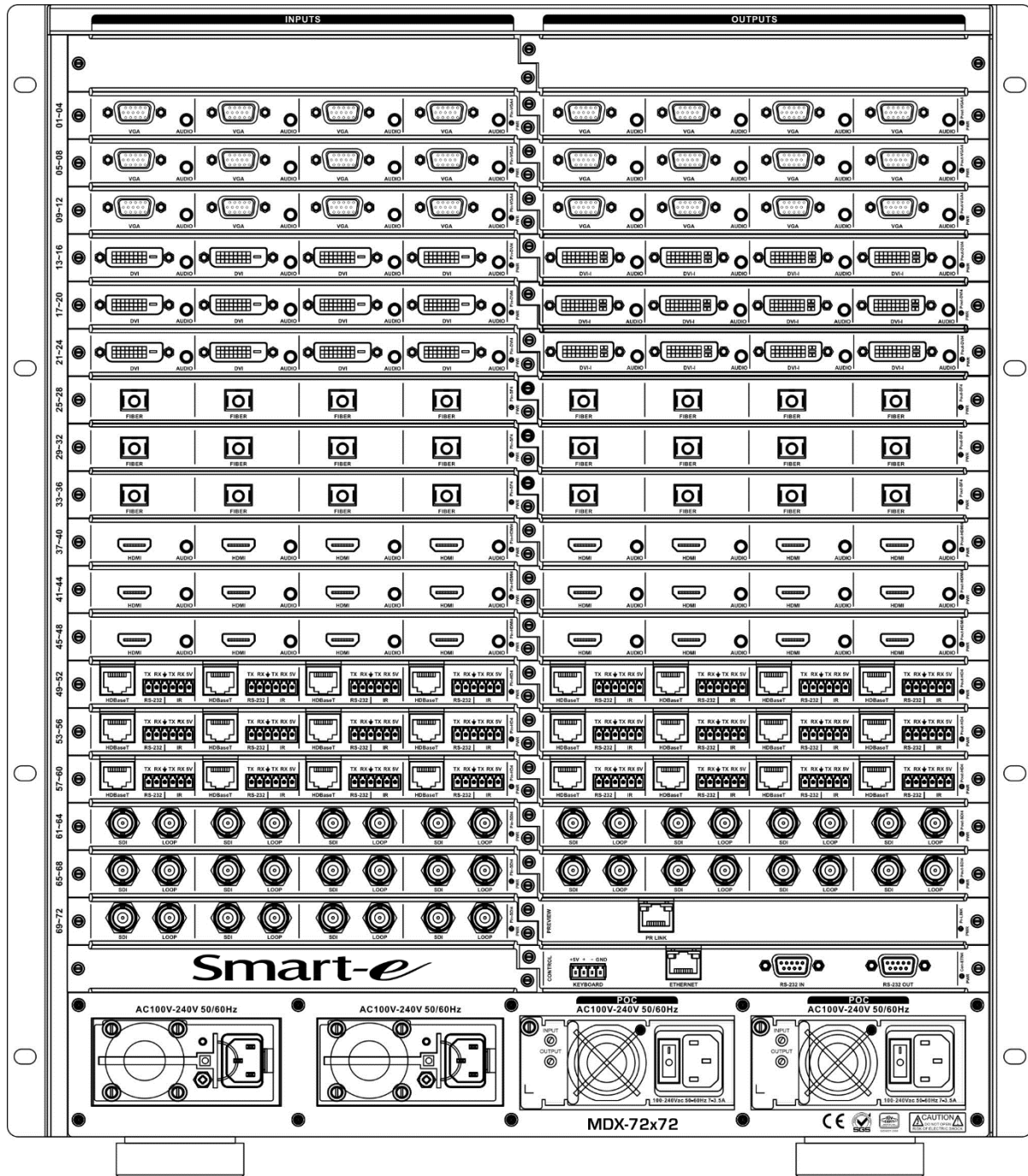

5 INPUT / OUTPUT BLADES

5.1 INPUT BLADES

5.1.1 HDMI 4-WAY INPUT BLADE [MDXE-IP4-HDMI]

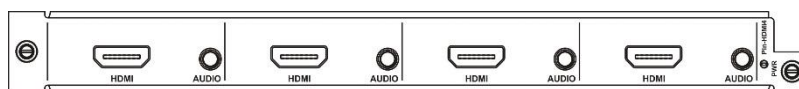

- Inserts to any Input Blade slot on the Matrix Chassis
- Provides 4x independent HDMI [Type-A] inputs
- Provides 4x independent 3.5mm stereo jack inputs for external stereo audio
- Compatible with HDMI 1.4 standard
- Compatible with HDCP 1.3 protocol
- Compatible with DVI 1.0 protocol
- Supports EDID editing function
- Maximum input resolution:
 - HDCP: 1920x1200p @ 60Hz 24bit
 - HDTV: 1920x1080p @ 60Hz 36bit (HD1080p60)
- Maximum recommended input cable length ≤15-meters (always use high quality cable)

5.1.2 DVI 4-WAY INPUT BLADE [MDXE-IP4-DVI]



- Inserts to any Input Blade slot on the Matrix Chassis
- Provides 4x independent DVI [Type-D] inputs
- Provides 4x independent 3.5mm stereo jack inputs for external stereo audio
- Compatible with HDMI 1.4 standard
- Compatible with HDCP 1.3 protocol
- Compatible with DVI 1.0 protocol
- Supports EDID editing function
- Maximum input resolution:
 - HDCP: 1920x1200p @ 60Hz 24bit
 - HDTV: 1920x1080p @ 60Hz 36bit (HD1080p60)
- Maximum recommended input cable length ≤15-meters (always use high quality cable)

5.1.3 ANALOGUE 4-WAY INPUT BLADE [MDXE-IP4-VGA]

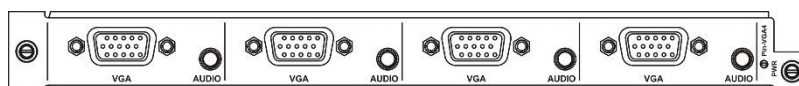

- Inserts to any Input Blade slot on the Matrix Chassis
- Provides 4x independent Analogue [HD15] inputs
- Provides 4x independent 3.5mm stereo jack inputs for external stereo audio
- VGA/RGBHV
- Supports: Component YPbPr, Y/C S-video, Composite-video (using adapter cable)
- Maximum input resolution:
 - HDCP: 1920x1200p @ 60Hz 24bit
 - HDTV: 1920x1080p @ 60Hz 36bit (HD1080p60)

- Digitises and up-scales input resolution $\leq 1920 \times 1080p @ 60Hz$

5.1.4 HDBASET 4-WAY RECEIVER BLADE [MDXE-RX4-HDBT]

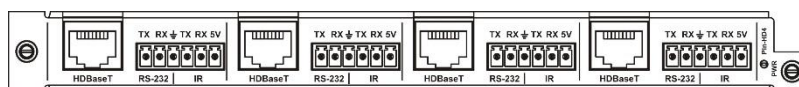

- Inserts to any Input Blade slot on the Matrix Chassis
- Provides 4x independent HDBaseT [RJ45] inputs (Receive)
- Provides 4x independent full duplex RS232 serial connections (1 per channel)
- Compatible with HDBaseT protocol
- Supports EDID editing function
- Maximum input resolution:
 - HDCP: 1920x1200p @ 60Hz 24bit
 - HDTV: 1920x1080p @ 60Hz 36bit (HD1080p60)
- Maximum recommended input cable length ≤ 100 -meters (always use high quality cable)

5.1.5 FIBRE 4-WAY RECEIVER BLADE [MDXE-RX4-MFB]



- Inserts to any Input Blade slot on the Matrix Chassis
- Provides 4x independent FUSION LINK HDBaseT multimode optical fibre [SC/OM3] inputs (Receive)
- Compatible with HDBaseT protocol
- Supports EDID editing function
- Maximum input resolution:
 - HDCP: 1920x1200p @ 60Hz 24bit
 - HDTV: 1920x1080p @ 60Hz 36bit (HD1080p60)
- Maximum recommended input cable length ≤ 100 -meters (always use high quality cable)

5.1.6 HD/3G SDI INPUT BLADE (MDXE-IP4-3GSDI)



- Inserts to any Input Blade slot on the Matrix Chassis
- Provides 4x independent BNC inputs each with a local loop output
- Compatible with HDSDI & 3GSDI protocols
- Supports EDID editing function
- Maximum input resolution:
 - HDCP: 1920x1200p @ 60Hz 24bit
 - HDTV: 1920x1080p @ 60Hz 36bit (HD1080p60)
- Maximum recommended input cable length ≤ 15 -meters (always use high quality cable)

5.2 OUTPUT BLADES

5.2.1 HDMI 4-WAY OUTPUT BLADE [MDXE-OP4-HDMI]

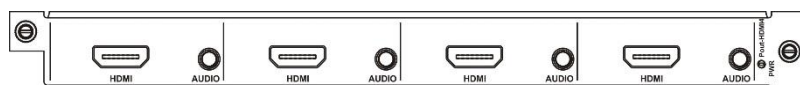

- Inserts to any Output Blade slot on the Matrix Chassis
- Provides 4x independent HDMI [Type-A] outputs
- Provides 4x independent 3.5mm stereo jack outputs for de-embedded stereo audio
- Compatible with HDMI 1.4 standard
- Compatible with HDCP 1.3 protocol
- Compatible with DVI 1.0 protocol
- Supports individual output port scaling
- Maximum output resolution:
 - HDPC: 1920x1200p @ 60Hz 24bit
 - HDTV: 1920x1080p @ 60Hz 36bit (HD1080p60)
- Maximum recommended output cable length ≤5-meters (always use high quality cable)

5.2.2 DVI 4-WAY OUTPUT BLADE [MDXE-OP4-DVI]



- Inserts to any Output Blade slot on the Matrix Chassis
- Provides 4x independent DVI [Type-D] outputs
- Provides 4x independent 3.5mm stereo jack outputs for de-embedded stereo audio
- Compatible with HDMI 1.4 standard
- Compatible with HDCP 1.3 protocol
- Compatible with DVI 1.0 protocol
- Supports individual output port scaling
- Maximum output resolution:
 - HDPC: 1920x1200p @ 60Hz 24bit
 - HDTV: 1920x1080p @ 60Hz 36bit (HD1080p60)
- Maximum recommended output cable length ≤5-meters (always use high quality cable)

5.2.3 ANALOGUE 4-WAY OUTPUT BLADE

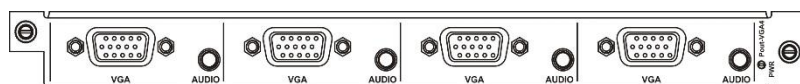

- Inserts to any Output Blade slot on the Matrix Chassis
- Provides 4x independent Analogue [HD15] inputs
- Provides 4x independent 3.5mm stereo jack inputs for de-embedded stereo audio
- VGA/RGBHV
- Supports: Component YPbPr, Y/C S-video, Composite-video (using adapter cable)
- Supports individual output port scaling
- Maximum output resolution:
 - HDPC: 1920x1200p @ 60Hz 24bit
 - HDTV: 1920x1080p @ 60Hz 36bit (HD1080p60)
- Maximum recommended output cable length ≤5-meters (always use high quality cable)

5.2.4 HDBASET 8-WAY TRANSMIT BLADE [MDXE-TX4-HDBT]

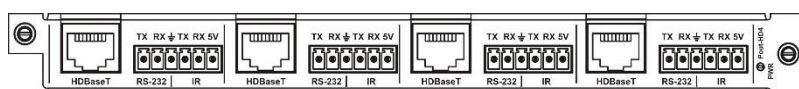

- Inserts to any Output Blade slot on the Matrix Chassis
- Provides 4x independent HDBaseT [RJ45] outputs (Transmit)
- Provides 4x independent full duplex RS232 serial connections (1 per channel)
- Compatible with HDBaseT protocol
- Supports individual output port scaling
- Maximum output resolution:
 - HDPC: 1920x1200p @ 60Hz 24bit
 - HDTV: 1920x1080p @ 60Hz 36bit (HD1080p60)
- Maximum recommended output cable length ≤100-meters (always use high quality cable)

5.2.5 FIBRE 8-WAY TRANSMIT BLADE [DX-TX4-FIBRE]

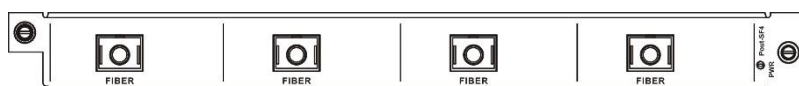

- Inserts to any Output Blade slot on the Matrix Chassis
- Provides 4x independent HDBaseT multimode optical fibre [SC/OM3] outputs (Transmit)
- Compatible with HDBaseT protocol
- Supports individual output port scaling
- Maximum input resolution:
 - HDPC: 1920x1200p @ 60Hz 24bit
 - HDTV: 1920x1080p @ 60Hz 36bit (HD1080p60)
- Maximum recommended input cable length ≤100-meters (always use high quality cable)

5.2.6 HD/3G SDI OUTPUT BLADE [MDXE-OP4-3GSDI]

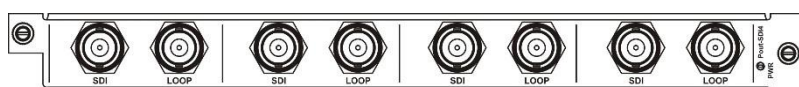

- Inserts to any Output Blade slot on the Matrix Chassis
- Provides 4x independent BNC outputs each with a local loop mirrored output
- Compatible with HDSDI & 3GSDI protocol
- Supports individual output port scaling
- Maximum input resolution:
 - HDPC: 1920x1200p @ 60Hz 24bit
 - HDTV: 1920x1080p @ 60Hz 36bit (HD1080p60)
- Maximum recommended input cable length ≤15-meters (always use high quality cable)

7 REMOTE CONTROL INTERFACES

7.1 RS232 SERIAL CONTROL PORT INTERFACE

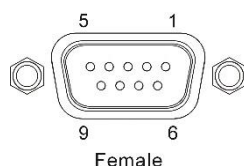

PIN	Function	PIN	FUNCTION
1	Not Used	6	Not Used
2	RS232 send data	7	Not Used
3	RS232 receive data	8	Not Used
4	Not Used	9	Not Used
5	Ground Earth	10	Not Used

7.2 KEYPAD CONTROL PORT INTERFACE



PIN	Function	PIN	FUNTION
1	Outputs +5V [DC5V/1A]	3	RS485 DATA-
2	RS485 DATA+	4	GND Ground Earth

7.3 TCP/IP CONTROL PORT INTERFACE

7.3.1 TCP/IP CONNECTION VIA SWITCH

Utilise a standard CatX twisted pair patch cable between the TCP/IP control port and a network switch.

Both ends of the patch cable should be terminated to EIA/TIA 568B standard:

EIA/TIA 568B Standard Linear Order							
PIN 1	PIN 2	PIN 3	PIN 4	PIN 5	PIN 6	PIN 7	PIN 8
White/Orange	Orange	White/Green	Blue	White/Blue	Green	White/Brown	Brown

7.3.2 TCP/IP CONNECTION DIRECT VIA CROSS-CONNECT

Utilise a “cross-connect” CatX twisted pair patch cable between the TCP/IP control port and the Ethernet LAN port on a computer.

One end of the patch cable should be terminated to EIA/TIA 568B standard:

EIA/TIA 568B Standard Linear Order							
PIN 1	PIN 2	PIN 3	PIN 4	PIN 5	PIN 6	PIN 7	PIN 8
White/Orange	Orange	White/Green	Blue	White/Blue	Green	White/Brown	Brown

One end of the patch cable should be terminated to EIA/TIA 568A standard:

EIA/TIA 568A Standard Linear Order							
PIN 1	PIN 2	PIN 3	PIN 4	PIN 5	PIN 6	PIN 7	PIN 8
White/Green	Green	White/Orange	Blue	White/Blue	Orange	White/Brown	Brown

8 ACCESSORIES

8.1 MULTIFORMAT ANALOGUE VIDEO ADAPTER CABLE

A multi-format analogue video adapter cable can be utilised with any input on the SDX-IP8-VGA Blade to facilitate the connectivity to various types of analogue video device.

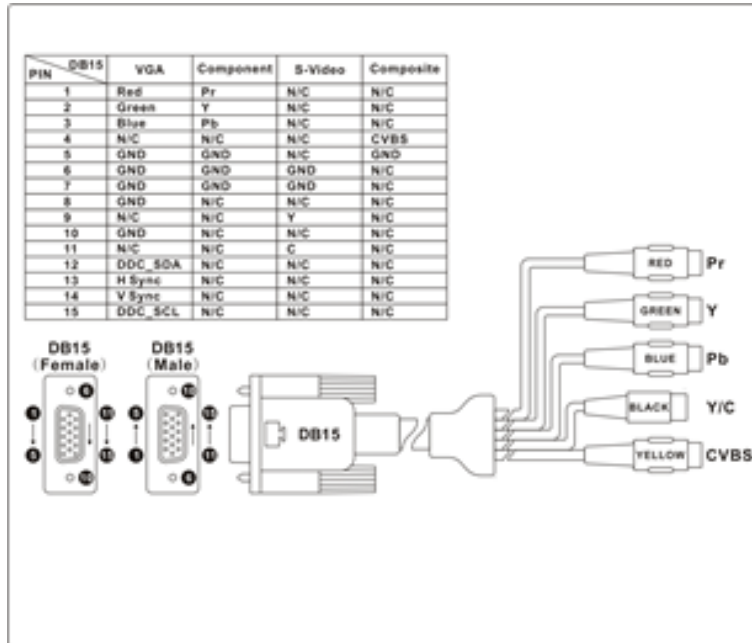

9 TECHNICAL SPECIFICATION

9.1 MDXE-8X8+ / 16X16+ / 36X36+

Model Specifications	8x8	16x16	36x36	72x72
Interface				
Number of input boards/input channels	2/8	4/16	9/36	18/72
Number of output boards/output channels	2/8	4/16	9/36	18/72
Supported input board type	MDXE-IP4-HDMI; MDXE-IP4-DVI; MDXE-RX8-HDBT; MDXE-IP4-VGA; MDXE-RX4-MFB; MDXE-IP4-3GSDI			
Supported seamless output board type	MDXE-OP4-HDMI; MDXE-OP4-DVI; MDXE-TX8-HDBT; MDXE-OP4-VGA; MDXE-TX4-MFB; MDXE-OP4-3GSDI;			
Interface bandwidth	6.75Gbps			
Serial port control				
Serial control interface	RS-232, 9 pin female D type interface and 9 pin male D type interface			
Baud rate and protocol	Baud rate: 9600, data bits: 8 bits, stop bits: 1 bit, no parity check bit			
Serial control interface structure	9 pin female D type interface: 2 = TX, 3 = RX, 5 = GND; 9 pin male D type interface: 2 = RX, 3 = TX, 5 = GND			
KEYBOARD control interface				
Keyboard control interface	Four-way 3.8mm phoenix interface			
Operation method	To use with external keypad			
Keyboard control interface structure	+5V=DC5V, + = DATA+, -=DATA- GND = signal ground			
Ethernet control				
Ethernet control interface	RJ-45 female interface			
Ethernet control protocol	TCP/IP			
Ethernet control speed rate	Adaptive 10M / 100M, full-duplex or half-duplex			
Specifications				
System power	100VAC ~ 240VAC, 50/60 Hz, International adaptive power			
Storage, working temperature	0 ~ +50°C			
Storage, working humidity	20% ~ 70%			
Chassis size	2U	3U	7U	12U
Product weight (without boards)	About 5Kg	About 7Kg	About 16Kg	About 29Kg
Full power (without boards)	About 18W		About 30W	
Size	445x400x88	445x400x132	445x400x310	445x400x533
Mean time between failures	30,000 hours			
Quality guarantee	3-year return to base warranty			

9.2 MDXE-IP4-HDMI / MDXE-OP4-HDMI

PROTOCOLS	
Protocols	Complete support for the HDMI1.4 protocol of 3D, including support for the mainstream of 3D display mode in HDMI 1.4 protocol, but does not include the 3D_1080P@120Hz downward compatible with HDMI 1.3 standard, HDCPI.3 protocol, DVI.I.O protocol.
VIDEO	
Interface	4x independent HDMI [Type-A] Female
Gain	0 dB
Pixel Bandwidth	165MHz Full Digital
Interface Bandwidth	2.25Gbps, Full digital [a total of 6.75Gbps, each colour is 2.25Gbps]
Maximum Resolution	PC: 1600x1200 @ 60Hz 24bit HDPC: 1920x1200p @ 60Hz 24bit HDTV: 1920x1080p @ 60Hz 36bit (HD 1080p60)
Clock Jitter	<0.15T bit
Rise Time	<0.3T bit (20%~80%)
Fall Time	<0.3T bit (20%~80%)
Maximum Transmission Delay	5ns (±1 ns)
Signal Strength	T.M.D.S +/- 0.4Vpp
Minimum/Maximum Level	T.M.D.S 2.9V / 3.3V
Impedance	50Ω
EDID	Optional default EDID and load function [MDXE-IP4-HDMI]
Maximum DC offset error	15mV
Maximum Input Cable	[MDXE-IP4-HDMI] ≤15-meters @ 1920x1200 60Hz (always use high quality cable)
Maximum Output Cable	[MDXE-OP4-HDMI] ≤15-meters @ 1600x1200 @ 60Hz (always use high quality cable)
PHYSICAL	
Form Factor	MDXE Blade
Weight	500g
Maximum Power Consumption	8W [DX-IP8-HDMI] / 8W [DX-OP8-HDMI]

9.3 MDXE-IP4-DVI / MDXE-OP4-DVI

PROTOCOLS	
Protocols	DVI I.O protocol. Compatible with HDMI 1.3 standard, HDCPI.3 protocol
VIDEO	
Interface	4x independent DVI-D Female
Gain	0 dB
Pixel Bandwidth	165MHz Full Digital
Interface Bandwidth	2.25Gbps, Full digital [a total of 6.75Gbps, each colour is 2.25Gbps]
Maximum Resolution	PC: 1600x1200 @ 60Hz 24bit HDPC: 1920x1200p @ 60Hz 24bit HDTV: 1920x1080p @ 60Hz 36bit (HD 1080p60)
Clock Jitter	<0.15T bit
Rise Time	<0.3T bit (20%~80%)
Fall Time	<0.3T bit (20%~80%)
Maximum Transmission Delay	5ns (±1 ns)
Signal Strength	TMDS +/- 0.4Vpp

Minimum/Maximum Level	T.M.D.S 2.9V / 3.3V
Impedance	50Ω
EDID	Optional default EDID and load function [MDXE-IP4-DVI]
Maximum DC offset error	15mV
Maximum Input Cable	[MDXE-IP4-DVI] ≤15-meters @ 1920x1200 60Hz [always use high quality cable]
Maximum Output Cable	[MDXE-OP4-DVI] ≤15-meters @ 1600x1200 @ 60Hz [always use high quality cable]
PHYSICAL	
Form Factor	MDXE Blade
Weight	500g
Maximum Power Consumption	8W [MDXE-IP4-DVI] / 8W [MDXE-OP4-DVI]

9.4 MDXE-IP4-VGA / MDXE-OP4-VGA

VGA/RGBHV VIDEO	
Interface	4x independent Multi-format Analogue [HD15] Female
Signal Type	VGA/RGBHV
Gain	0 dB
Bandwidth	380 MHz
Differential Phase Error	-
Differential Gain Error	-
Maximum Resolution	PC: 1600x1200 @ 60Hz 24bit HDPC: 1920x1200p @ 60Hz 24bit HDTV: 1920x1080p @ 60Hz 36bit (HD 1080p60)
Signal Strength	0.63V p-p ~ 0.9V p-p
Minimum/Maximum Level	RGB Signal: 0~1V / HV Signal: 0~5V
Impedance	75Ω
Echo Loss	< -20dB @ 5MHz
COMPONENT VIDEO	
Interface	4x independent Multi-format Analogue [HD15] Female (Using adapter cable)
Signal Type	Component-video YPbPr / YCbCr
Gain	0 dB
Bandwidth	350MHz @ -3dB
Differential Phase Error	0.1°, 3.58-4.43 MHz
Differential Gain Error	0.1%, 3.58-4.43 MHz
Maximum Resolution	PC: 1600x1200 @ 60Hz 24bit HDPC: 1920x1200p @ 60Hz 24bit HDTV: 1920x1080p @ 60Hz 36bit (HD 1080p60)
Signal Strength	1V p-p (Component video in Y) 0.3Vp-p (Component video in YPbPr/YCbCr)
Minimum/Maximum Level	Analogue Signal: ±2V
Impedance	75Ω
Echo Loss	< -30dB @ 5MHz
Y/C S-VIDEO	
Interface	4x independent Multi-format Analogue [HD15] Female (Using adapter cable)
Signal Type	Y/C S-video
Gain	0 dB

Bandwidth	150MHz @ -3dB
Differential Phase Error	0.1°, 3.58-4.43 MHz
Differential Gain Error	0.1%, 3.58-4.43 MHz
Signal Strength	1V p-p S Terminal Video (Y/C)
Minimum/Maximum Level	Analogue Signal: ±2V
Impedance	75Ω
Echo Loss	< -30dB @ 5MHz
COMPOSITE VIDEO	
Interface	4x independent Multi-format Analogue [HD15] Female (Using adapter cable)
Signal Type	Composite-video
Gain	0 dB
Bandwidth	150MHz @ -3dB
Differential Phase Error	0.1°, 3.58-4.43 MHz
Differential Gain Error	0.1%, 3.58-4.43 MHz
Digitisation and Scaling	
Signal Strength	1V p-p Composite Video(CVBS)
Minimum/Maximum Level	Analogue Signal: ±2V
Impedance	75Ω
Echo Loss	< -30dB @ 5MHz
PHYSICAL	
Form Factor	MDXE Blade
Weight	1.2Kg
Maximum Power Consumption	8W [MDXE-IP4-VGA] / 8W [MDXE-OP4-VGA]

9.5 MDXE-RX4-HDBT / MDXE-TX4-HDBT

PROTOCOLS	
Protocols	HDBaseT
VIDEO	
Interface	4x independent HDBaseT [RJ45] Female
Gain	0 dB
Pixel Bandwidth	165MHz Full Digital
Interface Bandwidth	2.25Gbps, Full digital (a total of 6.75Gbps, each colour is 2.25Gbps)
Maximum Resolution	PC: 1600x1200 @ 60Hz 24bit HDPC: 1920x1200p @ 60Hz 24bit HDTV: 1920x1080p @ 60Hz 36bit (HD 1080p60) 3D: 1920x1080p @ 24Hz 36bit
Clock Jitter	<0.15T bit
Rise Time	<0.3T bit (20%~80%)
Fall Time	<0.3T bit (20%~80%)
Signal Type	High speed differential signal defined in HDBaseT protocol
PoE	+24V
EDID	Optional default EDID and load function [MDXE-RX4-HDBT]
RS232 Serial Control Signal	Pass-through
Infrared Control Signal	Pass-through
Maximum DC offset error	15mV

Maximum Input Cable	[MDXE-RX4-HDBT] ≤100-meters [CAT 6/6A STP]
Maximum Output Cable	[MDXE-TX4-HDBT] ≤100-meters [CAT 6/6A STP]
PHYSICAL	
Form Factor	MDXE Blade
Weight	1Kg
Maximum Power Consumption	25W [DX-RX8-HDBT] / 16W [DX-TX8-HDBT]

9.6 MDXE-RX4-MFB / MDXE-TX4-MFB

VIDEO	
Interface	4x independent FUSION LINK HDBaseT Single Core Fibre [SC/OM3]
Optical Fibre Type	Multimode Single Core Optical Fibre
Wavelength	Multimode 850nm
Interface Bandwidth	Positive: 6.25Gbps / Reverse: 3.125Gbps
Maximum Resolution	PC: 1600x1200 @ 60Hz 24bit HDPC: 1920x1200p @ 60Hz 24bit HDTV: 1920x1080p @ 60Hz 36bit (HD 1080p60)
Clock Jitter	<0.15T bit
Rise Time	<0.3T bit (20%~80%)
Fall Time	<0.3T bit (20%~80%)
Signal Type	High speed differential signal defined in HDBaseT protocol
EDID	Optional default EDID and load function [MDXE-RX4-MFB]
RS232 Serial Control Signal	Pass-through
Infrared Control Signal	Pass-through
Maximum DC offset error	15mV
Maximum Input Cable	[MDXE-RX4-MFB] ≤300m @ 1920x1080p 60Hz (always use high quality cable)
Maximum Output Cable	[MDXE-TX4-MFB] ≤300m @ 1920x1080p 60Hz (always use high quality cable)
PHYSICAL	
Form Factor	MDXE Blade
Weight	1Kg
Maximum Power Consumption	15W [MDXE-RX4-MFB] / 15W [MDXE-TX4-MFB]

9.7 MDXE-IP4-3GSDI / MDXE-OP4-3GSDI

VIDEO	
Interface	4x independent BNC connectors (Plus 4 independent local loop outs)
Interface Bandwidth	Positive: 6.25Gbps / Reverse: 3.125Gbps
Maximum Resolution	PC: 1600x1200 @ 60Hz 24bit HDPC: 1920x1200p @ 60Hz 24bit HDTV: 1920x1080p @ 60Hz 36bit (HD 1080p60)
Clock Jitter	<0.15T bit
Rise Time	<0.3T bit (20%~80%)
Fall Time	<0.3T bit (20%~80%)
Signal Type	HD-SDI / 3G-SDI
EDID	Optional default EDID and load function
Maximum DC offset error	15mV

Maximum Input Cable	15 meters @ 1920x1080p 60Hz (always use high quality cable)
Maximum Output Cable	15 meters @ 1920x1080p 60Hz (always use high quality cable)
PHYSICAL	
Form Factor	MDXE Blade
Weight	1Kg
Maximum Power Consumption	15W [MDXE-IP4-3GSDI] / 15W [MDXE-OP4-3GSDI]

10 FRONT PANEL CONTROL

10.1 CHANNEL SELECTION

Selecting input 2 to output 7. First select the button number 2 for the input followed by the V/M button on the Control pad. Next select the output number 7 followed by the enter button to make the selection.



10.2 IP SETUP

Set the IP address by first pressing the IP button on the Command Selection. The number can be changed by using the left and right arrowed buttons to position the cursor before selecting a new number from the Channel Number Selection.



10.3 PORT NUMBER

The Port number can be altered by pressing the IP button again and the LCD display will change to the view below:



10.4 GATEWAY

The Gateway can be altered by pressing the IP button again and the LCD display will change to the view below:



10.5 SUBNET MASK

The Subnet Mask can be altered by pressing the IP button again and the LCD display will change to the view below:



11 WEB BROWSER CONTROL

11.1 CHANNEL SELECTION

The internal Web Browser can be access via the Web port on the rear of the matrix. Simply launch a web browser on your PC or device and type in the IP address 192.168.1.191.

When accessing the web page the first time it will ask you for a User name and Password, the default is Admin and Admin respectively. Once through this process you will then see the channel selection page below:

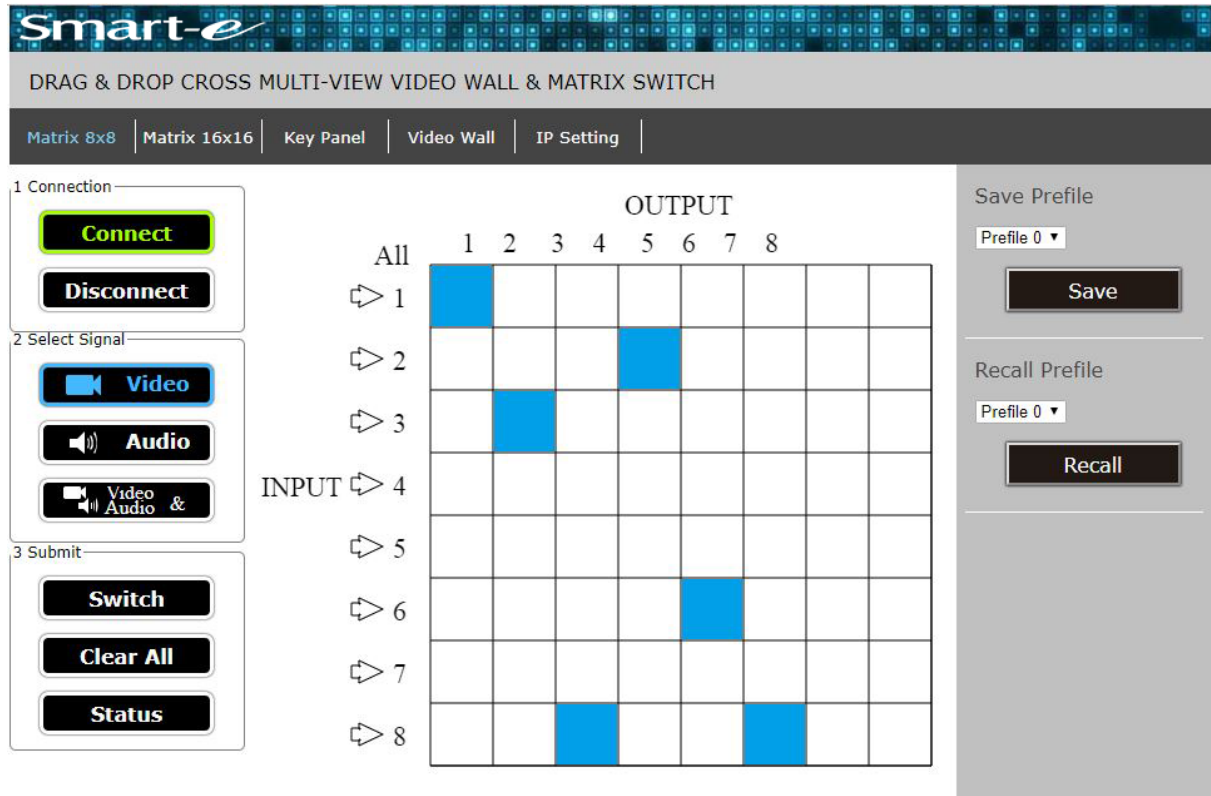

selecting a square on the matrix view and the square will colour blue to indicate a crosspoint selection. Profiles (frequently used configurations) can be saved and recalled at will using the righthand buttons.

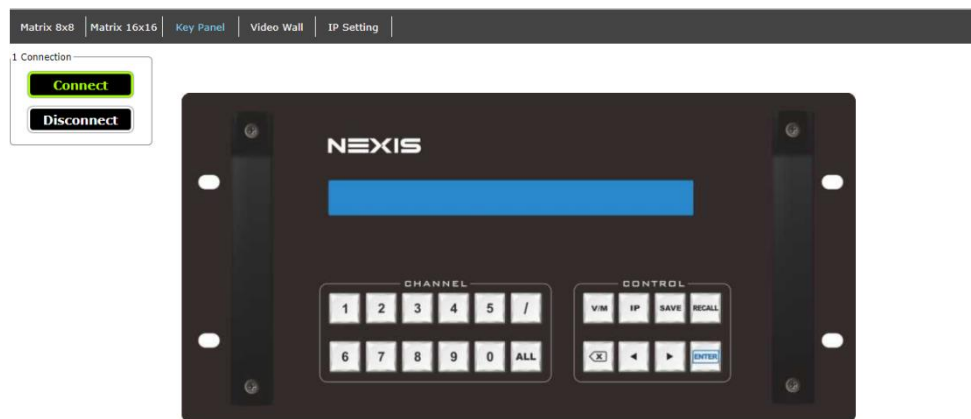

Alternatively, control can be via the keypad option, replicating the functions of the front panel

11.2 IP SETTINGS

All IP settings for the Web Browser can be altered by selecting the appropriate tab:

The screenshot displays the NEXIS web interface for configuring IP settings. At the top, the NEXIS logo is visible above the text "DRAG & DROP CROSS MULTI-VIEW VIDEO WALL & MATRIX SWITCH". Below this is a navigation bar with tabs for "Matrix 8x8", "Matrix 16x16", "Key Panel", "Video Wall", and "IP Setting".

The "IP Setting" tab is active, showing a configuration window for "ETHERNET". On the left, there is a "1 Connection" section with "Connect" and "Disconnect" buttons. The main configuration area includes a table for setting parameters:

ETHERNET	
IP	setip
PORT	setport
MARK	setmark
GATEWAY	setgateway
MAC	setMAC
factory reset	

Below the table are tabs for "Local IP config" and "Misc config". The "Local IP config" tab is selected, showing a "parameter" configuration window with the following fields:

- IP Type: Static IP (dropdown)
- Static IP: 192 . 168 . 1 . 191
- Submask: 255 . 255 . 255 . 0
- Gateway: 192 . 168 . 1 . 1
- Dns Server: 192 . 168 . 1 . 1

At the bottom of the configuration window are "Save" and "Cancel" buttons.